

# The Most Affordable, Quality Adjustable Height Workbench is Now Available—Only from IAC

## Introducing the **930 and 940 Pro Series**

All new for 2013, the ergonomically designed 930/940 Pro Series delivers the efficiency and convenience of height adjustability at a remarkable price. We've engineered these workbenches for quality performance. A cantilever support system, housing the hydraulic lifters, provides maximum leg room, while the bolted steel channel frame delivers a full 500-pound evenly-distributed load capacity. You can easily move up or down to the efficient functionality of a height adjustable worksurface.

**930 Pro Series:** Height adjustment is manually controlled by a rotating hand crank positioned on the right or left side under the worksurface support frame. The crank handle folds out of the way when not in use.

**940 Pro Series:** Height adjustment is electrically actuated via Up/Down pushbuttons. This controller is positioned on the right or left side, under the worksurface support frame.

### Features:

- 12-inch adjustment range, from 30" to 42" worksurface height
- 1-1/4" thick worksurface with 180° rolled front edge for comfort. Surfaces are available in Standard or ESD laminate, with a wide variety of colors.
- Welded steel frame, finished in a choice of durable, baked-on powder-coat paint.
- Available options for suspended drawers/cabinets, electrical channels, and upper utility structures with shelving and lighting offer endless configurations.



*940 Pro Series Adjustable Height Workbench, shown with optional EZE Reach upper utility structure and suspended drawer.*



*930 Pro Series hand crank height control.*



*940 Pro Series electric button height control.*



*Cantilever leg support houses hydraulic height control mechanism. Lower, horizontal beam increases strength and durability.*

### 930 Series—Hand Crank

Length	Depth	Worksurface	
		Standard Laminate	ESD Laminate
48"	30"	1005801	1011801
	36"	1005811	1011811
60"	30"	1005802	1011802
	36"	1005812	1011812
72"	30"	1005803	1011803
	36"	1005813	1011813

### 940 Series—Motorized Hydraulic

Length	Depth	Worksurface	
		Standard Laminate	ESD Laminate
48"	30"	1005821	1011821
	36"	1005831	1011831
60"	30"	1005822	1011822
	36"	1005832	1011832
72"	30"	1005823	1011823
	36"	1005833	1011833

## Suspended Drawers and Cabinets



All Pro Series drawers feature 100 lbs. capacity, full-extension, metal roller bearing slides which deliver quiet, smooth operation.

Recessed handles for safety.

Single Locks and other options are available.

Drawer Depth = 20"

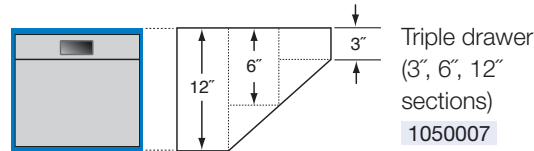
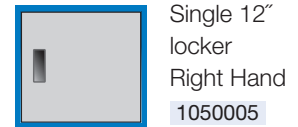
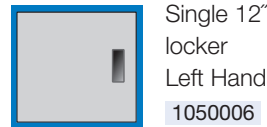
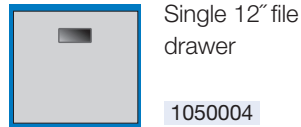
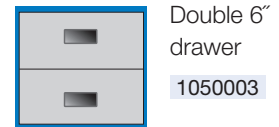
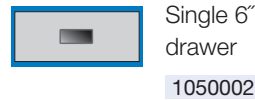
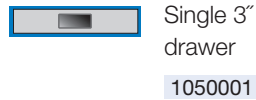

### Drawer Options

Cylinder Lock	Master Key Set
1050033	1050035

## Electrical Channels

TE-2 Electrical Channels include: 15 amp circuit breaker/pilot light switch, 8 ft. molded power cord, mounting hardware and eight outlets.

Workbench Length	OVER Top Electrical
48"	1022121
60"	1022122
72"	1022123

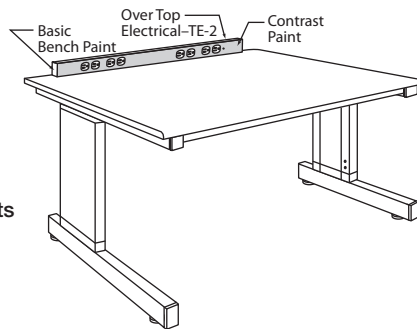

In Use with EZE Reach Posts

Workbench Length	OVER Top Electrical
48"	1022129
60"	1022121
72"	1022122

## Slide-Out Universal CPU Holder

- Safely suspends the CPU beneath the worksurface, saves valuable workspace
- Slide mechanism permits easy access to CPU
- Prevents damage from dust, floor, moisture, vacuum cleaning or mops
- Rugged metal construction, durable powder coated paint finish
- 28 lbs. capacity pulls out 12" and rotates 360° Part painted texture black.

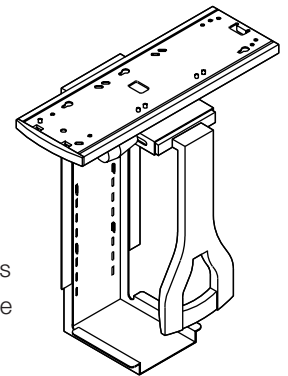

1021659

## EZE Reach Upright Post Sets

Transform your 930 or 940 Pro Series workbench into a productivity station. EZE Reach Upright Posts mount to the worksurface and allow the workbench to be equipped with shelving, lighting and swing arm accessories. Posts are dual-slotted at 1-inch increments for accessory positioning, and support up to 150 lbs. of weight. Finished in wear-resistant powder coat paint to match your workbench.

### EZE Reach Accessories

- Overhead Task Light
- Tool Trolley
- Sheet metal or wire shelving
- Swing arm document holders, computer display mounts, keyboard holders, and more
- Bin Rails for parts cups, tool holder, solder holders, and more

